

CONTINUOUS AND SELECTIVE DETERMINATION OF WATER VAPOR EVOLVED DURING THERMAL DECOMPOSITION REACTIONS

J. Kristóf, J. Inczédy*, J. Paulik and F. Paulik*

*DEPARTMENT OF ANALYTICAL CHEMISTRY, UNIVERSITY OF VESZPRÉM, H-8201
VESZPRÉM POB 158, HUNGARY
DEPARTMENT OF GENERAL AND ANALYTICAL CHEMISTRY, TECHNICAL
UNIVERSITY, H-1502 BUDAPEST, HUNGARY

(Received August 2, 1990)

A method suitable for the continuous and selective determination of water vapor evolved during thermal decomposition processes is described. The water detector can be connected to thermoanalytical equipment of controlled gas atmosphere without any difficulty. Water vapor, together with other gaseous decomposition products, is collected by the carrier gas and transported through a glass reaction vessel containing the measuring and reference cells. The change in cell temperature is sensed by a resistance thermometer coil connected to a bridge circuit. The relationship between the area under the recorded curve and the amount of water released is linear. Hydrocarbons, organic crack products, CO, CO₂, SO₂, SO₃ and NH₃ do not interfere. The detection limit is about 0.1 mg water, the reproducibility of the recorded curves is better than 10 per cent. In addition to the semi-quantitative determination of water, the detector trace can be recorded simultaneously along with the TG, DTG and DTA curves and used to identify the decomposition step(s) in which water was formed.

The use of evolved gas analysis (EGA) techniques in thermoanalytical investigations of various solid substances is of high importance in the determination of the nature and amount of volatile products formed upon heating. Via the determination of the evolved components conclusions can be drawn regarding the phase composition of the solid sample.

Different types of thermoanalytical equipment (thermobalances, DTA-apparatus, etc.) are connected to gas chromatographs [1], mass spectrometers [2], thermogas titrimetric equipment [3], FTIR instruments [4], and others. Compared to the basic thermoanalytical techniques, these complex methods provide additional information on the decomposition process.

Many thermal decomposition reactions are accompanied with release of water. It is often necessary to know if water vapor has been formed in the reaction, to follow continuously the water releasing process(es) and to determine the amount of water formed.

In practice a great variety of methods is available for the determination of the water content of different gases. These methods are listed in Table 1. However, the number of methods suitable for the determination of the time-dependent water content of flowing gases is rather limited.

In view of the continuous and selective monitoring of water vapor evolved during thermoanalytical investigations the number of potential techniques is further reduced because of lack of selectivity, non-linear response, long response and recovery times, etc.

A new method has been developed for the continuous determination of water evolved during thermal decomposition reactions [39, 40]. Water, together with other decomposition products, is collected by the carrier gas and transported through a detector cell containing a hygroscopic material, lithium chloride. Water is bound in the cell by the reagent material, and the increase in cell temperature caused by the heat of absorption (hydration) is measured. The amount of heat released is linearly proportional to the water formed in the decomposition process.

Experimental

The schematic diagram of the water detector is shown in Fig. 1. Two identical metal (silver or gold) cylinders comprising the measuring 8 and reference 7 cells are accommodated in a glass reaction vessel having ground glass stoppers 5 and 6. Teflon supports 11 hold the cells in concentric position. The inner wall of the cells is covered by glass fiber filter papers 9 and 10. In the measuring cell dry lithium chloride is deposited on the surface of the glass fiber. The temperature of the cells is measured by resistance thermometer coils 12 and 13 connected in series-opposition. Carrier gas mixed with decomposition products enters the device through port 1 and leaves it through port 2. If water is present in the carrier gas a certain amount of water (about 50%) is bound by the hygroscopic reagent material and an equivalent amount of heat (heat of hydration) is released, causing the cell temperature to increase. The change in temperature is sensed by the measuring coil (via the change of its resistance) connected to a Wheatstone bridge, while the temperature of the reference cell remains unchanged. The

Table 1. Methods available for the determination of water in gases

Physical methods	Chemical methods	Electrical methods	Optical methods	Other methods
Density measurements [5]	Karl Fischer titration [9]	Dielectrometry [16]	Colorimetry [22, 23, 24, 25, 26]	Gas chromatography [32, 33, 34, 35, 36]
Mass measurement [6]	Acid-base titration [10, 11]	Conductometry [8, 17]	Infrared spectro-photometry [4, 27]	Calorimetry [37,38]
Vapour pressure measurement [7]	Coulometry [8, 12, 13, 14]	Capacitance measurement [18]	Helium flowing afterglow [28]	Mass spectrometry [1,2]
Condensation methods [8]	Other methods [15]	Piezoelectrical detectors [19, 20, 21]	Laser spectrophotometry [29, 30]	
Psychrometry [8]			Helium microwave plasma emission spectrometry [31]	

heat of adsorption is removed from the cell by the carrier gas and, to a lesser degree, by heat loss.

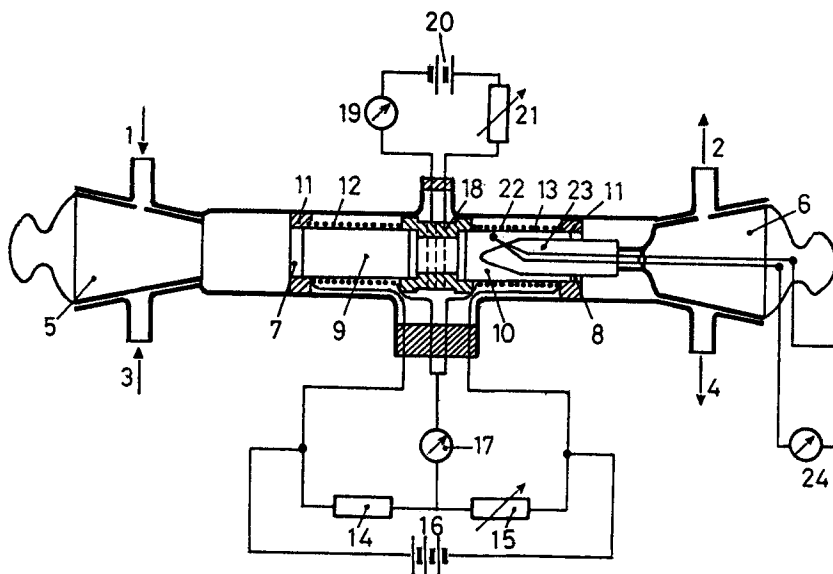

Fig. 1 Schematic diagram of the water detector. 1: carrier gas inlet, 2: carrier gas outlet, 3: regeneration gas inlet, 4: regeneration gas outlet, 5,6: ground glass stoppers, 7: reference cell, 8: measuring cell, 9: glass fiber filter paper, 10: glass fiber filter paper with LiCl reagent, 11: teflon support, 12: reference coil, 13: measuring coil, 14: resistor, 15: variable resistor, 16: power source, 17: recorder, 18: heating block, 19: ammeter, 20: power source, 21: variable resistor, 22: thermocouple, 23: glass cone, 24: mV meter

After measurement, the exhausted reagent material can be regenerated (dried out) without disassembling the detector tube. For this purpose dry nitrogen gas is passed through the device via ports (3) and (4). A heating block (platinum wires arranged according to a certain geometry) heats the regeneration gas to a temperature suitable for the 'in situ' drying of the reagent (approx. 180°). The role of the glass cone (23) is to provide close contact of the carrier/regeneration gas with the reagent material. The temperature of the regeneration gas is sensed by a thermocouple (22). For automatic regeneration a thermistor circuit is used. After cooling, the device is ready for the next measurement.

An EGA detector system of this type can be operated successfully only if the following requirements are met:

1. A strictly linear relationship is needed between the actual concentration of water vapor in the carrier gas and the amount of water bound by the reagent.

2. A linear relationship is necessary between the heat released and the amount of water bound in the cell.

3. The mass transfer (of water) from the gas phase to the solid reagent should be irreversible, otherwise the heat of desorption spoils the measurements.

4. Heat dissipation in the cell should occur at an appropriate rate so that rapid changes in the thermolysis process can be followed.

In order to meet the above conditions a very precise cell geometry was constructed to optimize the transfer, conductance and loss of heat.

Another crucial point is the structure of the glass fiber - lithium chloride system. Figure 2 shows thermoanalytical curves of glass fiber filter paper impregnated with aqueous lithium chloride solution. Two types of bound water can be observed in the DTG and DTA curves. The peak at 177° corresponds to the release of the first crystal water of LiCl. (The enthalpy of monohydration of dry LiCl at 18° is -15.95 kJ/mol.)

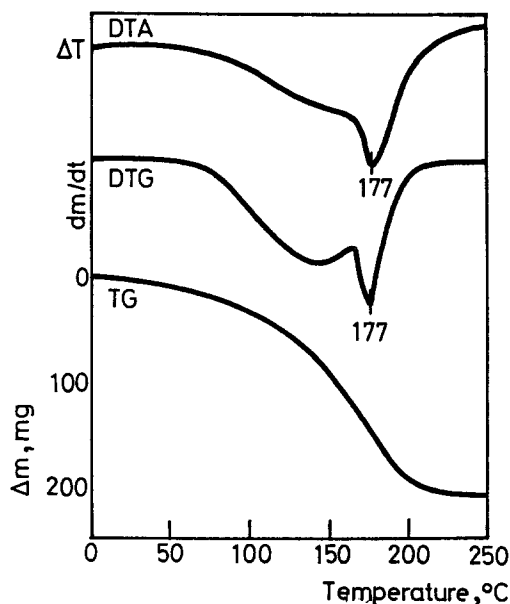

Fig. 2 Thermoanalytical curves of glass fiber filter paper impregnated with LiCl solution

Based on the curves it was concluded that the amount of adsorbed water should not exceed one mole throughout the entire reagent surface. The uptake of the second, third and further moles of water would cause gradually decreasing enthalpy changes. Thus linearity is no longer maintained.

An acceptable reagent system was prepared by the 'in situ' drying of glass filter paper impregnated three times with lithium chloride solutions of different concentration. Once the reagent material was prepared, we found that the device could be used for more than one hundred measurements without problem. After about one hundred measurements the reagent material should be replaced. If condensable organic matter (tar, crack products, etc.) is evolved, a more frequent replacement of the reagent is necessary.

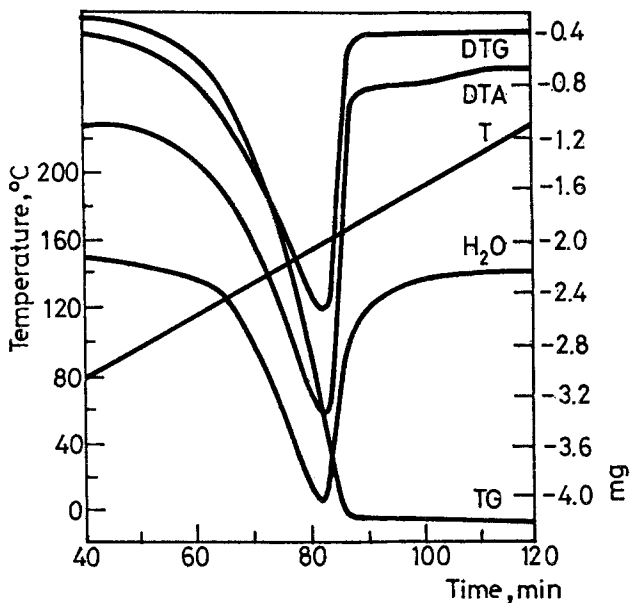

Fig. 3 Thermoanalytical curves for 28.35 mg $\text{Ca}(\text{COO})_2 \cdot \text{H}_2\text{O}$ and the signal of the water detector

The water detector was connected directly to a Derivatograph C-type thermoanalytical instrument (Hungarian Optical Works, Budapest). Nitrogen carrier gas mixed with gaseous decomposition products was passed through the detector at a flow rate of $10 \text{ dm}^3/\text{h}$. The trace of the detector was recorded simultaneously along with the TG, DTG and DTA curves.

Thermoanalytical curves for 28.35 mg calcium oxalate monohydrate $[\text{Ca}(\text{COO})_2 \cdot \text{H}_2\text{O}]$ including the signal curve of the water detector are given in Fig. 3. The heating rate was 5 deg/min in all cases. By comparing the water detector trace to the thermal decomposition curves the following conclusions can be drawn.

1. The signal of the detector closely follows the changes in concentration of water in the carrier gas (i.e. the shape of the DTG curve). The time delay is about 60 to 100 seconds, which can easily be eliminated by computer shifting of the water curve.

2. All the points of the curve produced by the detector are proportional to the actual concentration of water in the carrier gas.

The water detector trace of 11.40 mg crystalline copper(II) sulphate pentahydrate ($\text{CuSO}_4 \cdot 5\text{H}_2\text{O}$) is shown in Fig. 4. The detector can accurately follow the release of the five moles of crystal water (in three stages) with an extremely low noise level and excellent resolution. The curve peak areas for the three-stage water liberation process given as a function of the amount of water released in Fig. 5 indicate the linear characteristics of the detector that are essential for a continuous EGA monitor.

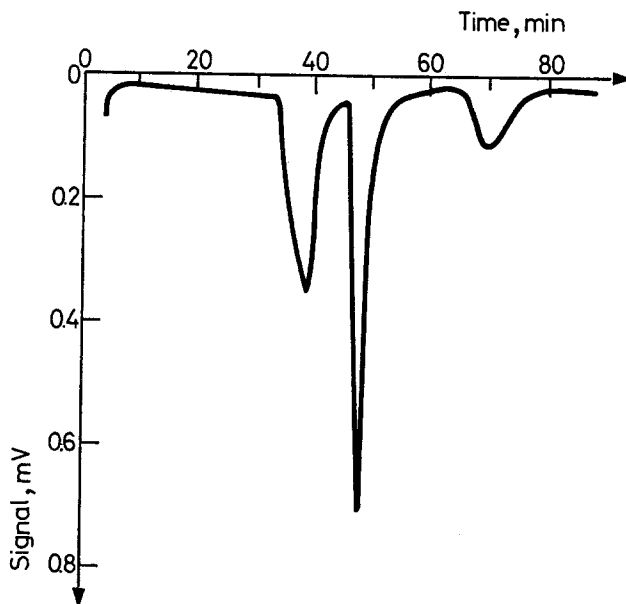

Fig. 4 Water detector trace of 11.40 mg $\text{CuSO}_4 \cdot 5\text{H}_2\text{O}$

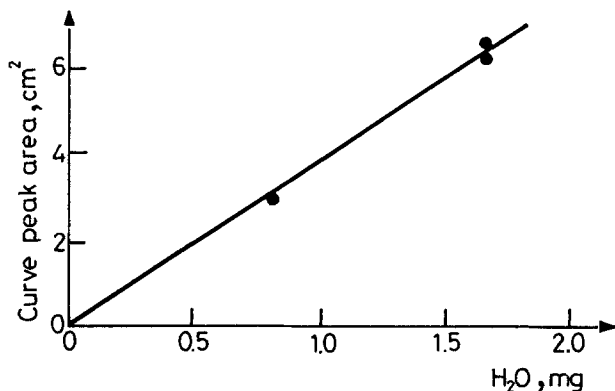

Fig. 5 The area under the water curve of Figure 4 as a function of the amount of water released

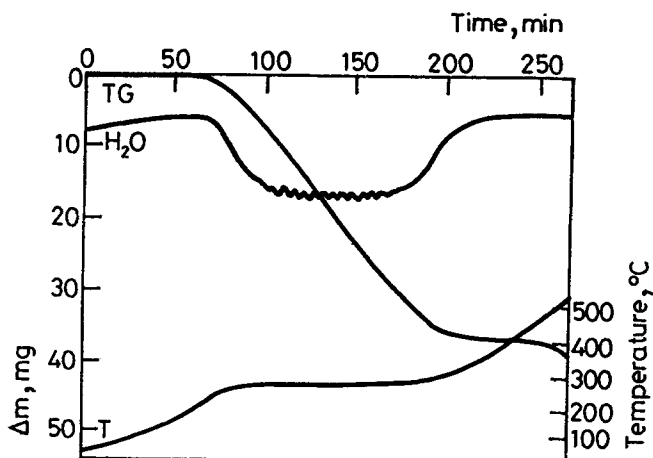
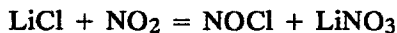

Fig. 6 Thermoanalytical curves of 297.5 mg $\text{Ca}(\text{COO})_2 \cdot \text{H}_2\text{O}$ under quasi-isothermal, quasi-isobaric conditions including the trace of the water detector

The applicability of the water detector under quasi-isothermal, quasi-isobaric measuring conditions was also investigated (the decomposition takes place at a constant, pre-set rate). For this purpose water release from 297.5 mg $\text{Ca}(\text{COO})_2 \cdot \text{H}_2\text{O}$ was investigated at a constant decomposition rate of 0.2 mg/min. Based on the recorded curves (Fig. 6) it can be stated that the detector can truly follow the water liberation process at constant rate. The sinusoidal character of the water curve (within the range of constant

decomposition rate) is due to fluctuation of the furnace temperature. This indicates the excellent dynamic behaviour of the device.

In order to use the detector as a reliable thermoanalytical tool, selectivity requirements should also be met. It was found that CO, CO₂, SO₂, SO₃, NH₃, amines, hydrocarbons, and organic crack products do not interfere. Thus, selective detection of water is possible in the presence of these compounds. The only interference found to date is NO₂. The suspected reaction is the following:



The detection limit is about 0.1 mg water. The reproducibility of the recorded curves was found to be better than 10 per cent.

The investigations carried out suggest that the device can expect widespread application in thermal analysis. The method has successfully been used for the solution of a great variety of problems, such as the identification and quantitative determination of differently bound waters in anion exchange resins [41], the study of ion exchanged zeolite catalysts containing rare earth cations [42], the investigation of dehydroxylation of clay minerals [43], the investigation of the flame retardation effect of inorganic salts on papermaking pulps [44] and the study of the decomposition of cobalt(III) pentamine complexes [45]. The advantage of the method lies in its inherent simplicity, selectivity, low cost, and the possibility of simultaneous measurements (the response curve of the device can be interpreted and evaluated along with simultaneously recorded thermoanalytical curves).

References

- 1 W. W. Wendlandt, *Thermal Methods of Analysis* 2nd ed.; Wiley-Interscience, New York 1974.
- 2 G. Szőr and S. Bohátka, *Thermochem Acta*, 92 (1985) 395.
- 3 J. Paulik and F. Paulik, *Talanta* 17 (1970) 1224.
- 4 D. A. C. Compton, *Int. Labmate*, (1987) 37.
- 5 J. Rütz, *Kernenergie* 14 (1971) 182.
- 6 A. S. Kiss, *Analyses in the Nitrogen Industry*, Műszaki Könyvkiadó, Budapest 1964.
- 7 J. Pohor and M. Hribar, *Croat. Chem. Acta*, 44 (1972) 399.
- 8 G. Pap and T. Mátyás, *Magyar Kémikusok Lapja* 1971, 7, 356-361.
- 9 R. Weintraub and A. Apelblat, *Anal. Chem.*, 54 (1982) 2627.
- 10 D. M. Smith and W. D. M. Bryant, *J. Am. Chem. Soc.*, 57 (1961) 841.
- 11 F. G. Roemer, C. J. W. Ginkel and B. F. A. Griepink, *Microchim. Acta*, 6 (1973) 957.
- 12 F. A. Keidel, US Patent, 2 830 945, 1958.
- 13 I. A. Capuano, British Patent, 1339 698, 1971.
- 14 R. S. Gray, I. Gordon and N. I. Forsyth, *Phys. A. Scient. Instrument*, 6 (1973) 1145.
- 15 H. W. Linde and L. B. Rogers, *Anal. Chem.*, 30 (1958) 1250.

- 16 F. Oehme, *Angew. Chem.*, 68 (1956) 457.
- 17 D. Sontag, *Microtechnic*, 20 (1966) 518.
- 18 A. Wexler, *Humidity and Moisture*, Reinhold Publ. Co., New York 1965.
- 19 W. H. Jr. King, *Anal. Chem.*, 36 (1964) 1735.
- 20 W. H. Jr. King, *Environ. Sci. Technol.*, 4 (1970) 1136.
- 21 C. W. Lee, Y. S. Fung and K. W. Fung, *Anal. Chim. Acta* 135 (1982) 277.
- 22 C. L. Luke, *Anal. Chim. Acta* 54 (1971) 447.
- 23 D. A. Otterson, *Anal. Chem.*, 33 (1961) 450.
- 24 C. E. Matkovich and G. D. Christian, *Anal. Chim. Acta*, 60 (1972) 319.
- 25 J. Shean-Ming and G. A. Parker, *Fresenius' Z. Anal. Chem.*, 315 (1983) 51.
- 26 E. Jungreis, *Anal. Chim. Acta*, 84 (1976) 201.
- 27 A. B. Kiss, *Acta Chim. Acad. Sci. Hung.*, 63 (1970) 243.
- 28 G. W. Taylor, E. J. Dowdy and J. M. Biery, *Anal. Chim. Acta*, 136 (1982) 277.
- 29 J. Reid, J. Shewchun, B. K. Garside and E. A. Ballik, *Appl. Opt.*, 17 (1978) 300.
- 30 M. Hamza, T. Kobayashi and H. Inaba, *Opt. Quantum. Electron.*, 13 (1981) 187.
- 31 S. Hanamura, B. Kirsch and J. D. Winefordner, *Anal. Chem.*, 57 (1985) 9.
- 32 I. M. Pirsada and J. H. Hills, *Analyst (London)* 108 (1983) 1096.
- 33 B. Scholz and K. Ballschmitter, *Fresenius' Z. Anal. Chem.* 302 (1980) 264.
- 34 F. F. Andrawes, *Anal. Chem.*, 55 (1983) 1869.
- 35 Y. Verdier and C. Desforges, *Analysis* 11 (1983) 390.
- 36 S. Latif, J. K. Haken and M. S. Wainwright, *J. Chromatogr.* 258 (1983) 233.
- 37 K. Mangold, B. Doerenkaemper and H. Schweers, *Fresenius' Z. Anal. Chem.*, 314 (1983) 563.
- 38 P. Marik-Korda and K. Szöke, *Acta Pharm. Hung.*, 51 (1981) 111.
- 39 J. Kristóf, J. Inczédy, J. Paulik and F. Paulik, *Hungarian Patent* 174 783, 1976.
- 40 J. Kristóf, J. Inczédy, J. Paulik and F. Paulik, *J. Thermal Anal.*, 15 (1979) 151.
- 41 J. Kristóf and J. Inczédy, *Thermal Anal.*, 19 (1980) 51.
- 42 J. Kristóf, G. Gárdos and A. Rédey, *J. Thermal Anal.*, 22 (1981) 123.
- 43 J. Kristóf, I. Vassányi, E. Nemezc and J. Inczédy, *Thermochim. Acta*, 93 (1985) 625.
- 44 J. Papp, J. Kristóf and J. Inczédy, *Cellulose Chem. Technol.*, 15 (1981) 589.
- 45 J. Kristóf and A. Horváth, *J. Thermal Anal.*, in press.

Zusammenfassung — Es wird ein Verfahren beschrieben, das sich für eine kontinuierliche und selektive Bestimmung von Wasserdampf eignet, der bei thermischen Zersetzungsprozessen freigesetzt wird. Dieser Wasserdetektor kann ohne jegliche Schwierigkeiten an Geräte angeschlossen werden, die über eine kontrollierte Gasatmosphäre verfügen. Wasserdampf wird zusammen mit anderen gasförmigen Reaktionsprodukten vom Trägergas erfaßt und in ein gläsernes Reaktionsgefäß geleitet, welches Meß- und Bezugszellen enthält. Die Änderung der Zelltemperatur wird von einem in Brücke geschalteten Widerstandsthermometer detektiert. Zwischen der Fläche unter der registrierten Kurve und der Menge freigesetzten Wassers besteht ein linearer Zusammenhang, wobei sich Kohlenwasserstoffe, organische Zersetzungsprodukte, CO, CO₂, SO₂, SO₃ und NH₃ nicht störend auswirken. Die Nachweisgrenze liegt bei 0.1 mg Wasser, die Reproduzierbarkeit der registrierten Kurven ist besser als 10%. Zusätzlich zur halbquantitativen Bestimmung von Wasser kann die Detektorkurve simultan mit den TG-, DTG- und DTA-Kurven aufgezeichnet werden, um Zersetzungsstufen zu identifizieren, bei denen sich Wasser bildet.